

**Horizon**



# BQ-280PUR

PUR Binder

BOOKS  
ON DEMAND

**Space-saving and High Quality  
Single clamp PUR Perfect Binder**



## Superior binding quality and efficient operation.

### Features

1. **PUR Perfect Binding** – High quality PUR binding is assured with dual application drums and separate EVA / PSA side glue application. Drum application enables production of one to one variable thickness books with maximum quality control.
2. **Extended spine length** – Maximum book size is 385 x 320 mm / 15.15" x 12.59" and the maximum book thickness is 51 mm / 2".
3. **Variable thickness production** – Built in thickness caliper provides greater production efficiency for instant changeover and variable thickness book production. The BQ-280PUR provides unsurpassed production efficiency in a single clamp binder.
4. **EVA Glue** – Low temperature EVA glue (140 °C / 284 °F or below) can be used. The system can be used for both PUR and EVA with the same tank.
5. **JDF Workflow** – The system can be further enhanced with Horizon's pXnet bindery control system which integrates JDF workflow from upstream devices.

### PUR is strong and eco-friendly.

Polyurethane Reactive, also called PUR, is a popular due to its superior binding strength and eco-friendliness.

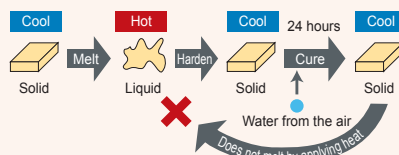

#### 1. Lay-flat

PUR glue is more flexible than EVA glue and provides lay flat qualities when the book is opened. It is ideal for music books and cookbooks, which are read on the desk, and two-page spread such as photo books. This lay-flat quality makes it easy to read books and extends the book life.



#### 2. High Binding Strength and Durability

The binding strength is about three times stronger than the EVA glue. Coated paper or specialty stocks, which can be a problem with EVA, are bound securely in PUR bound books. EVA glue binding strength becomes weaker over time. However, the PUR glue retains durability and flexibility in both high and low temperatures for long lasting book quality.

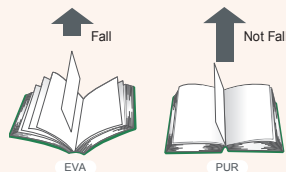

#### 3. Temperature Resistance / Unaffected by Ink

The PUR glue is unaffected by temperature and humidity compared to the EVA glue. This allows PUR bound books to be handled in almost any climate or location. If EVA is attached to printing area, solvent ink and EVA bring about reactions, causing a binding issues. However, PUR is not affected by ink solvent and reduces potential problems.

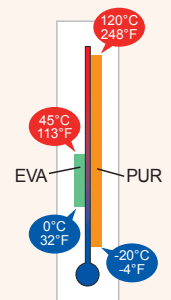

#### 4. Energy Saving / Cost Saving

The PUR glue can be applied at low temperature (120 °C / 248°F), and its high adhesiveness allows thin glue application (0.4 mm / 0.016").

#### 5. Ecology

The PUR is easy to be separated from paper by paper-manufacturing companies. It enables to recycle PUR bound books. Saving disposal cost. PUR is environmentally friendly and recyclable, which is perfect for the ISO14001 certified companies to produce catalogs and brochures.

### 1 Operation Console

The changeover can be completed in less than one minute by simply inputting job information at the color touchscreen. All setups including glue setup, nipping width, nipping height and scoring rollers can be adjusted automatically by the book block information.



### 2 Book Thickness Caliper

Book thickness caliper is provided as standard equipment. Book thickness is automatically measured by placing the book block into the digital caliper. Thickness data automatically begins set-up of each mechanism. The next thickness data automatically begins set-up while the previous book is still in-process. This provides operating efficiency for short-run book production.





## 3 Milling Section

A powerful milling mechanism and special milling blade for maximum paper fiber and clean spine preparation for PUR binding. Uniquely designed wire brush cleans up the spine and also prevents the milling chips from migrating into the glue tank.

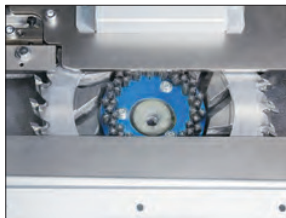

## 5 Cover Feeding Section / Scoring Section

Superior cover feeding is assured with suction rotary feeding system and ultra sonic double feed detection. Automatic cover scoring position adjustment through touchscreen. BQ-280PURFC is available with additional 2 flap cover scoring with automatic setup feature.



## 4 Glue Tank Unit

Open drum system enables easier setup and variable thickness production. Setups including glue amount adjustment, drum height, and wiper opening can be done through touchscreen.



## 6 Nipping Section

The automatic nipper height adjustment from the touchscreen allows for complete tool-less operation. A square spine is assured with the powerful and rigid nipping mechanism.

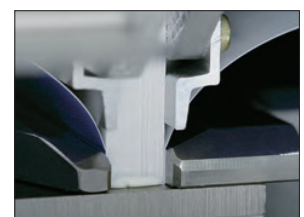

## Glue tank cleaning



Glue tank can be removed very easy for tank cleaning. Entire glue tank can be lowered with a simple touch of the touchscreen. The optional S-280 glue tank stand makes tank replacement much easier and safer.





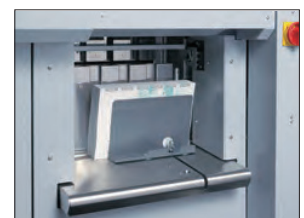

## 7 Delivery Section

Newly designed book delivery receives each book gently with elevator style delivery system to avoid damage on the spine for sensitive PUR bound books.



BQ-280PUR Specifications	
Binding Type	Binding with milling, Binding without milling, and Pad binding
Glue Type	PUR glue / Low temperature EVA glue
Number of Carriage Clamps	1
Book Block Size	Max. 385 x 320 mm / 15.15" x 12.59"
 Spine Length x Fore-edge Length	Min. 135 x 105 mm / 5.32" x 4.14"
Book Thickness	1 to 51 mm / 0.04" x 2"
 Length x Width	Max. 385 x 660 mm / 15.15" x 25.98" (Up to 350 mm or 13.77" forwards from the clamp face) (Up to 310 mm or 12.2" backwards from the clamp face)
	Min. 135 x 225 mm / 5.32" x 8.86" (Up to 115 mm or 4.52" forwards from the clamp face) (Up to 110 mm or 4.34" backwards from the clamp face)
Cover Weight Range	Normal Paper 82 to 302 gsm Coated Paper 105 to 349 gsm
Cover Pile Height	Max. 70 mm / 2.75"
Glue Temperature	Spine Glue Tank (PUR glue / Low temperature EVA glue): 110°C to 140°C / 230°F to 284°F Side Glue Tank (EVA glue): 150°C to 200°C / 302°F to 392°F
Cycle Speed	Max. 500 cycles per hour
Voltage/Frequency	3-phase 200 to 220V, 50 / 60 Hz
Machine Dimensions	W2,605 x D905 x H1,525 mm / W102.6" x D35.7" x H60.1" *If the machine is the flap cover model, the width becomes 100 mm / 3.94" wider.

## Option

Smoke Extractor VS-280	This unit is highly recommended with PUR use. The extractor continues to work for thirty minutes by the timer even after turning off the power.	
Barcode Verification System BC-BQ270	The barcode verification system is able to read the printed barcodes on the cover sheet and book block to match the cover sheet and the book block.	
Lining Guide KG-280	This guide positions a strip of lining which is fed manually on the nipper. Reinforcing strips for case binding can be positioned in the correct location.	
PUR Glue Heater M-470	The M-470 is a laboratory oven used to premelt the PUR glue of about 2 kg / 4.4 lb.	
Fluorine Resin Coating Beaker (With cover) B-470	The B-470 Fluorine-resin-coated beaker can be used to premelt the PUR glue of about 2 kg / 4.4 lb or to refill the glue tank.	
PUR Tank Set PTS-280	Spare tank for replacing the spine glue tank.	
Melt Tank Stand S-280	S-280 melt tank stand makes the replacement more easier. The S-280 stand is designed to receive and hold the spine glue tank unit after removal. (With casters)	
Fore-edge Gluing Unit	The fore-edge gluing is automated when the cover is supplied to the nipping section.	
Flap Cover Kit FLP-280	The fold line for flap covers can be scored in-line. Flap covers are then folded inward along the scoring line after binding.	

## Machine Dimension (Unit: mm / inch)

Provide 700 mm / 27.6" of space around the machine.  
The area about 700 mm / 27.6" around the machine is necessary space.  
Prepare proper fume extraction.

\*1 For fore-edge unit, 100 mm / 3.93" is added.  
\*2 The trim bag could be located depending on the installation location.

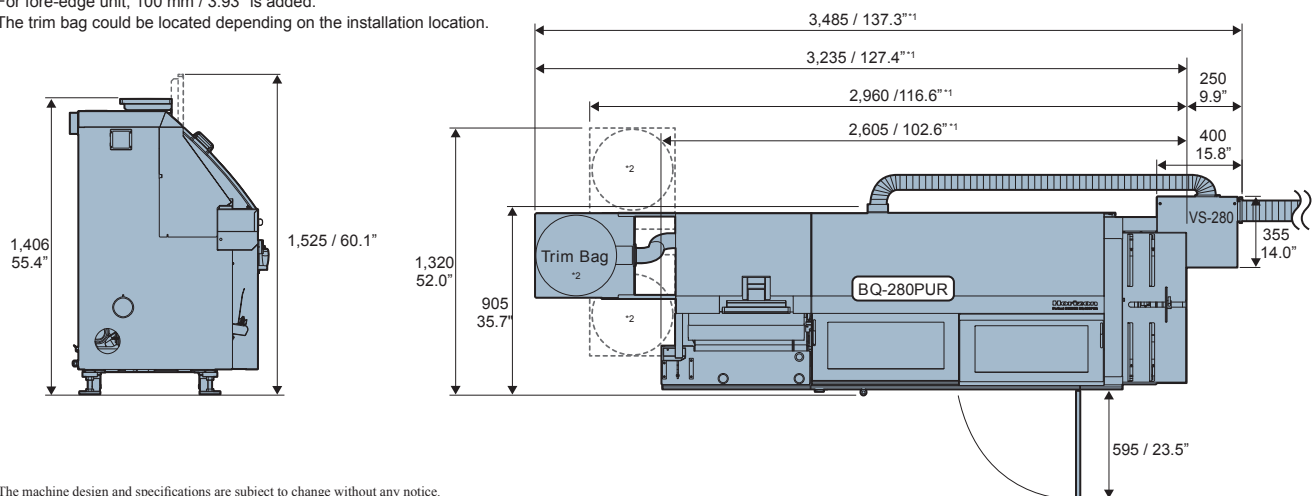

\*The machine design and specifications are subject to change without any notice.

